

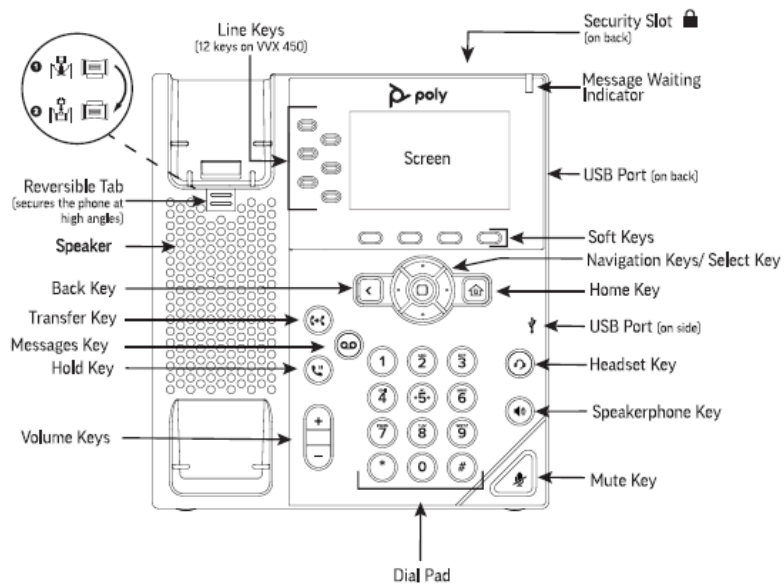









Phone User Guide – Poly VVX350



Keys	Functions
	Displays Home screen or Main Menu.
	Turns headset off/on.
	Turns speakerphone off/on.
	Mutes/unmutes the phone speaker.
	Holds a call. Resumes a held call.
	Transfers a call.
	Accesses voicemail.
	Adjusts the volume.

Placing a Call

Using the handset: Pick up the handset, dial number and press **Send** soft key. To use the speakerphone, press the speakerphone button  on the bottom right of the phone and place handset back in cradle.

Using the speakerphone: With the handset on hook, simply start dialing the number and press **Send** soft key.

Using a headset: Press the button on the headset earpiece, enter the phone number and press **Send** soft key.

TIP: Local numbers may be 7 digit dialing or may require the area code, depending on the area. Long distance numbers can be dialed with or without the 1+. Please contact your administrator for access to international dialing.

Answering a Call

Using the handset: When phone is ringing, pick up the handset.

To end the call, place handset back in cradle or press **End Call** soft key.

Using the speakerphone: When phone is ringing, press . Press Speakerphone button again to end the call.

Using the headset: When phone is ringing, press the button on the headset earpiece to answer the call. To end the call, press the headset button again or press **End Call** soft key.

Volume Adjustment

Use the volume keys to adjust the volume on the handset when you are on a handset call, on the speaker when you are on a speakerphone call, or ring volume when your phone is idle.

Redial

Touch New Call on soft keys, then use navigation keys located under soft keys to select a recently dialed number to redial. Press center OK button (in middle of navigation keys) to dial.



Muting yourself to callers

The mute button is on the lower right of the phone – it is in the shape of a triangle and has a mute icon  - Press that button to mute yourself to callers. You will see the microphone button turn red, indicating you are

muted to the caller. Press  again to unmute.

TIP: Mute can be used on handset, speakerphone and headset calls.

Call Hold

Press  or the **Hold** soft key during a call to place that call on hold. You will see a pause indication on your screen. To return to the caller, press  or the **Resume** soft key.

You can use the navigation keys to navigate if there is more than one call on hold on your phone.

TIP: A call on hold can only be retrieved from the phone where the call was placed on hold. Use transfer or the Park feature to place calls on hold that need to be retrieved from other phones on the system.

Call Transfer

Using Extension Buttons: If you have buttons for phones programmed on your phone, you can use them for quick dial and quick transfers. To transfer: when on an active call, press the extension button to transfer the call. The caller will immediately be routed to that phone and your phone will be idle.

TIP: Extension buttons are default programmed for blind transfer. If you need to announce the call before transferring the call, submit a service request to have that feature programmed.

Blind Transfer: When on an active call, press the **Transfer** soft key. The caller will be placed on hold. Enter the number you want to transfer to, then press the **B Transfer** soft key to send. OR press Cancel then Resume to return to the caller.

Attended Transfer: When on an active call, press the **Transfer** soft key. The caller will be placed on hold. Enter the number you want to transfer to, then press the **Send** soft key. Wait for the person to answer and announce the call. To transfer the call, press the **Transfer** soft key. If the person does not want to take the call, press the **End Call** soft key then press the **Resume** soft key to return to the caller.

Conference (3-way) calls

When on an active call, press the **More** soft key then the **Confrnc** soft key. Dial 2nd party and press **Send**. Wait for the 2nd party to answer, then press **More** then **Confrnc** soft key again to join the two calls together. Press **Split** soft key to resume individual calls. Press **Hold** soft key to place conference call on hold. Press **Manage** soft key to mute, hold, or remove either of the calls..

*TIP: When pressing **Split** soft key to resume individual calls, you can press the **Swap** soft key to move back and forth between the calls.*

Calling an extension on the system

Either dial the extension number or press the pre-programmed button to call another extension. To call over speakerphone, dial *0 then the extension number.

TIP: Submit a service request to have pre-programmed buttons programmed on your phone.

Call Park

Call Park is an enhanced hold feature that will allow you to place a call on hold that can be retrieved from any phone on the system. To place a call into a park orbit: Ask the caller to hold. Press an available Park orbit button on your phone – **Park 1**, **Park 2** etc. That park button will light in red on every phone on the system.

To retrieve a parked call, press the same park orbit button. The call information will show on the display. If the call is not retrieved, it will ring back to the phone that originally placed it on Park.

Voice Mail Set Up and Use

To set up your mailbox, press  to access your voice mail. For the initial setup – you will be prompted to enter your new password, then #. You will be prompted to reenter your password, then #. Then you will be prompted to record a greeting.

Once your mailbox is set up, you will receive notifications on your screen if you have new messages. Select  to call voice mail. Enter password when prompted.

You will hear how many messages you have. Press 1 to listen to your messages. When listening to messages, you can press 1 to save or 7 to delete. You can also press 3 to forward a message to another mailbox on the system.

To update password, greeting, or name in mailbox: Press 5 to manage your mailbox.

To change greeting press 1. To change name, press 2. To change password, press 3.

Your system may be enabled with the voice mail to email feature. If so, voice mails will come to your email as a .wav file and can be shared via email.

TIP: If you need a voice mail password reset, submit a service request.